

Sun shield parts	
1	Sun shield sheet
2	Support arms
3	RH end rib
4	Central rib
5	LH end rib
6	Stiffening bar
7	Washers

Sun shield can swing upwards to give access for cleaning Coanda screens. It bolts to the main box via 2-off M12 bolts (welded to support arms), washers and nyloc nuts.

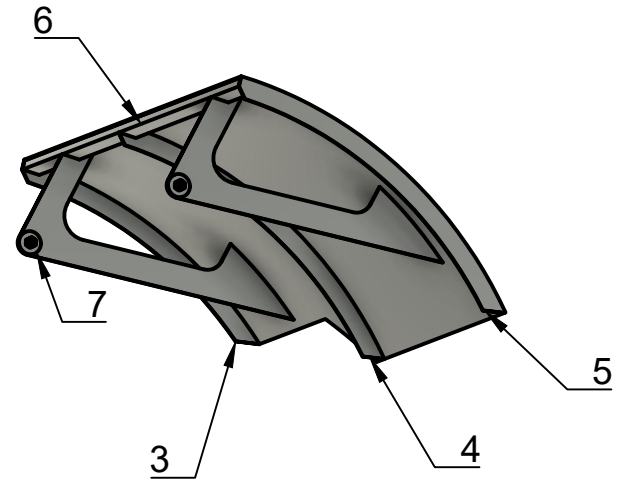
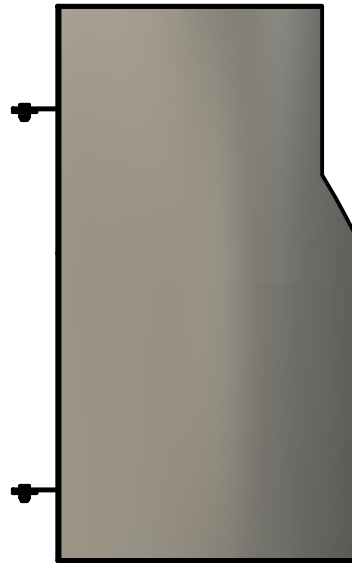
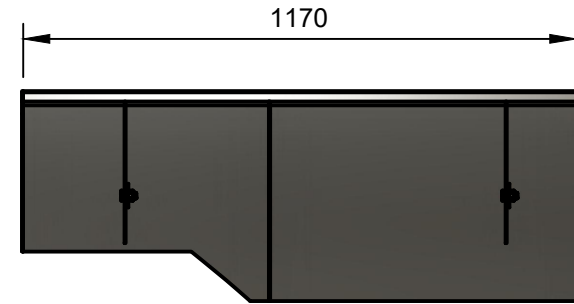
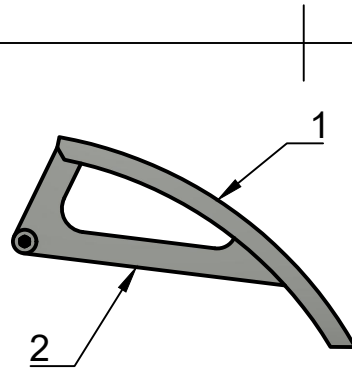
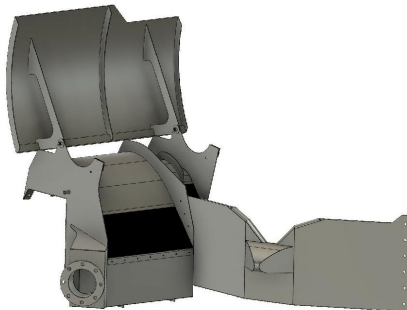
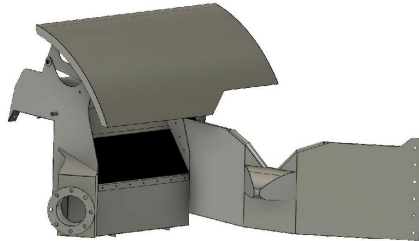

This slows the growth of algae in summer and provides some frost protection in winter.

Project: Hafod y Rhedwydd micro-hydro		Title: Sun shield		Projection 	
Material: 304L stainless		Drawing No. HyR_210325b		Paper size A4	
Thickness:		Designer: Dr. R.W.Moss		Default scale 1:16	
Required:		Units: mm		Revision date 05/07/2020	
Sheet 1 of 7		Sheet title Parts list		Rev. 0	

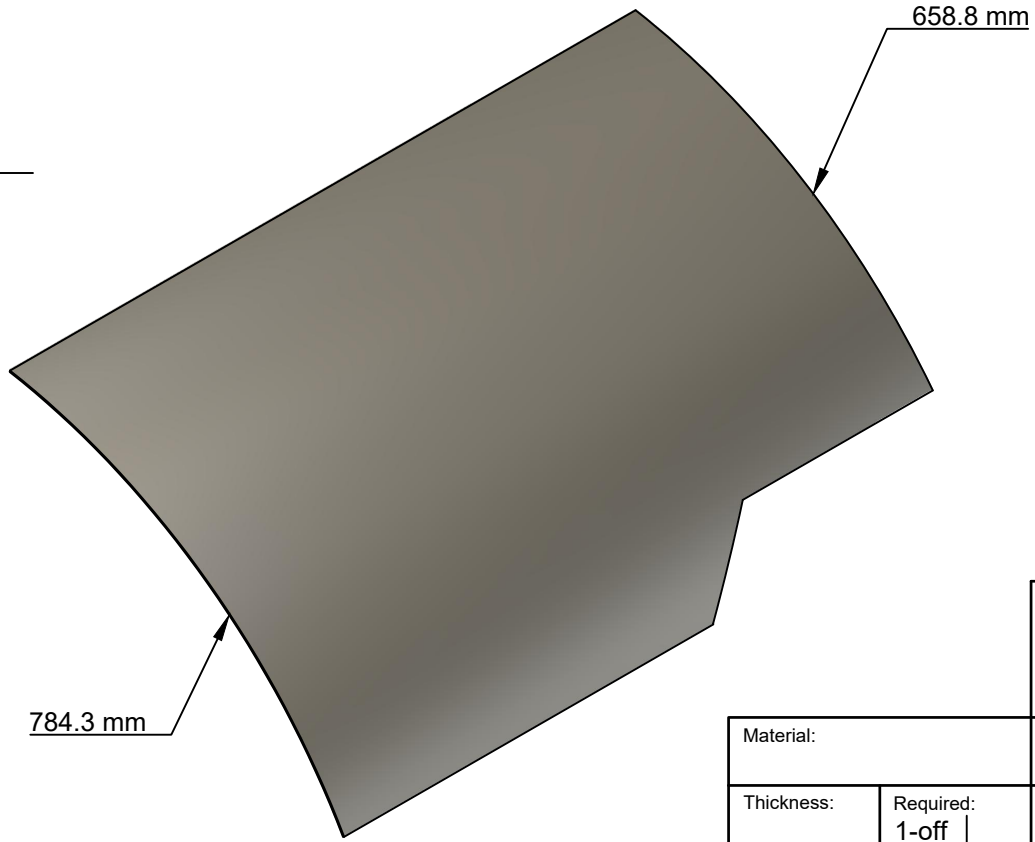
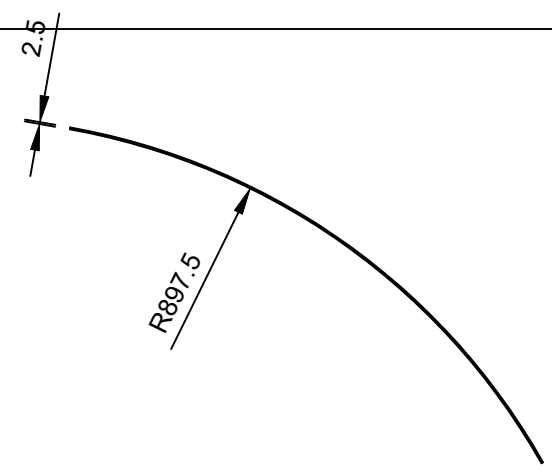
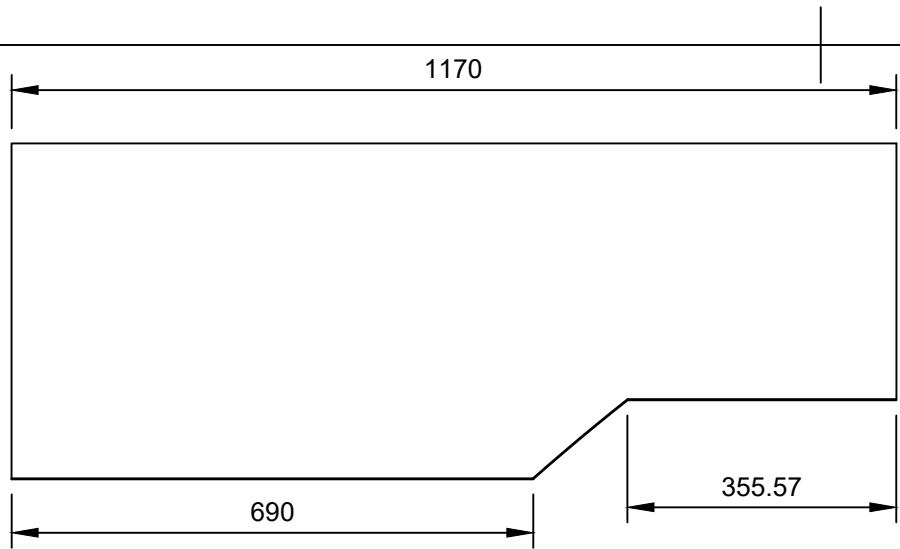

Developed lengths		
Internal radius	Angle	Mid-line length
897.5	50° (wide)	784.3
897.5	42° (narrow)	658.8

Project: Hafod y Rhedwydd micro-hydro		Title: Sun shield		Projection 	
Material:		Drawing No. HyR_210325b		Paper size A4	
Thickness:		Designer: Dr. R.W.Moss		Default scale 1:10	
Required: 1-off	Sheet 2 of 7	Sheet title Item 1: shield sheet		Units: mm	Revision date 05/07/2020
		Rev. 0			

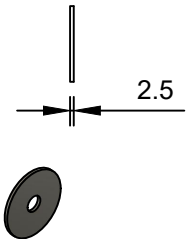
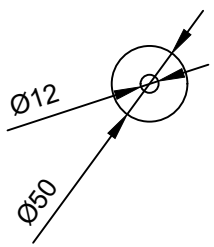
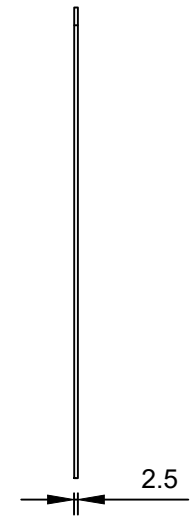
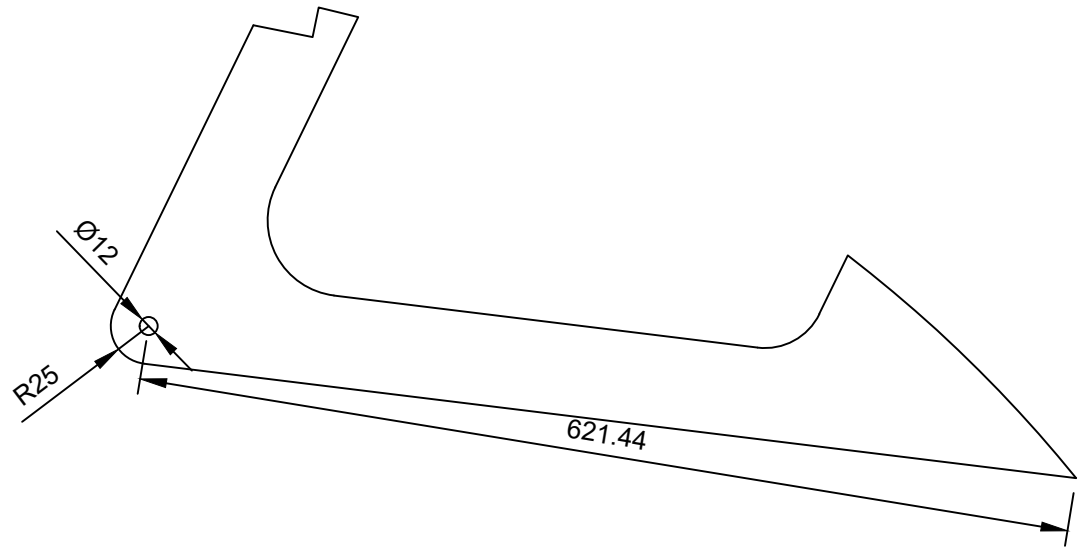

Project: Hafod y Rhedwydd micro-hydro		Title: Sun shield		Projection 	
Material:		Drawing No. HyR_210325b		Paper size A4	
Thickness:		Designer: Dr. R.W.Moss		Default scale 1:5	
Required: 2-off each		Sheet title Items 2&7: support arms and washers		Revision date 05/07/2020	
Sheet 3 of 7		Rev. 0		Revision date 05/07/2020	

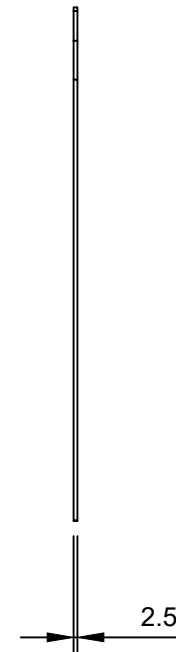
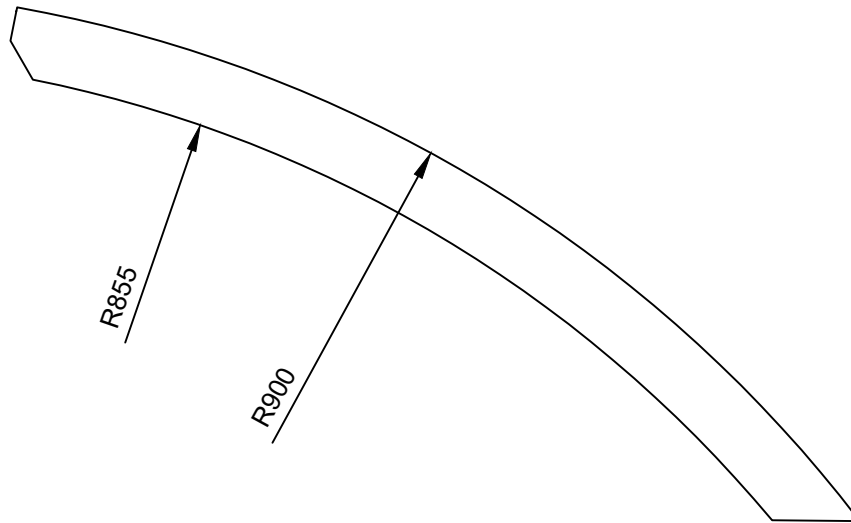

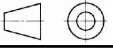
		Project: Hafod y Rhedwydd micro-hydro		Title: Sun shield		Projection 	
		Drawing No. HyR_210325b		Designer: Dr. R.W.Moss		Paper size A4	
Material:		Sheet 4 of 7		Units: mm		Default scale 1:5	
Thickness:	Required: 1-off	Sheet title Item 3: RH end rib		Rev. 0		Revision date 05/07/2020	

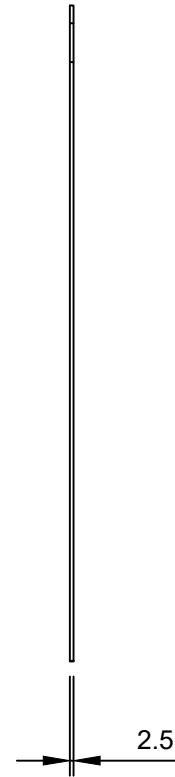
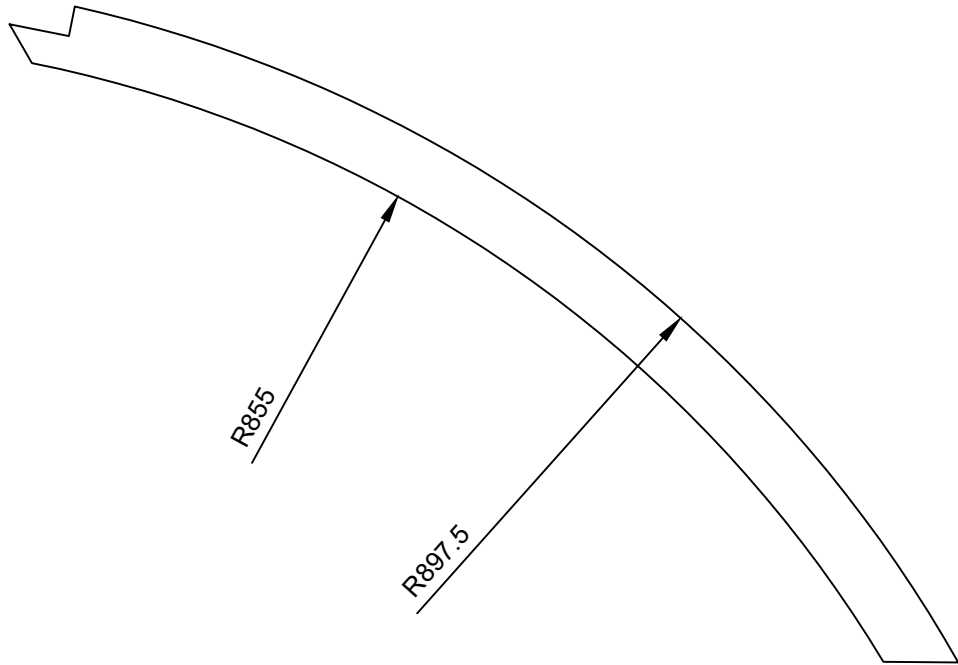

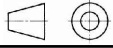
		Project: Hafod y Rhedwydd micro-hydro		Title: Sun shield		Projection 	
		Drawing No. HyR_210325b		Designer: Dr. R.W.Moss		Paper size A4	
Material:		Units: mm		Default scale 1:5			
Thickness:	Required: 1-off	Sheet 5 of 7	Sheet title Item 4: central rib		Rev. 0	Revision date 05/07/2020	

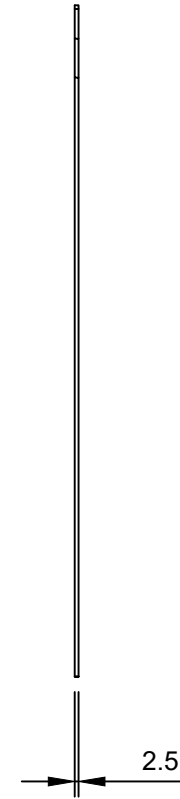
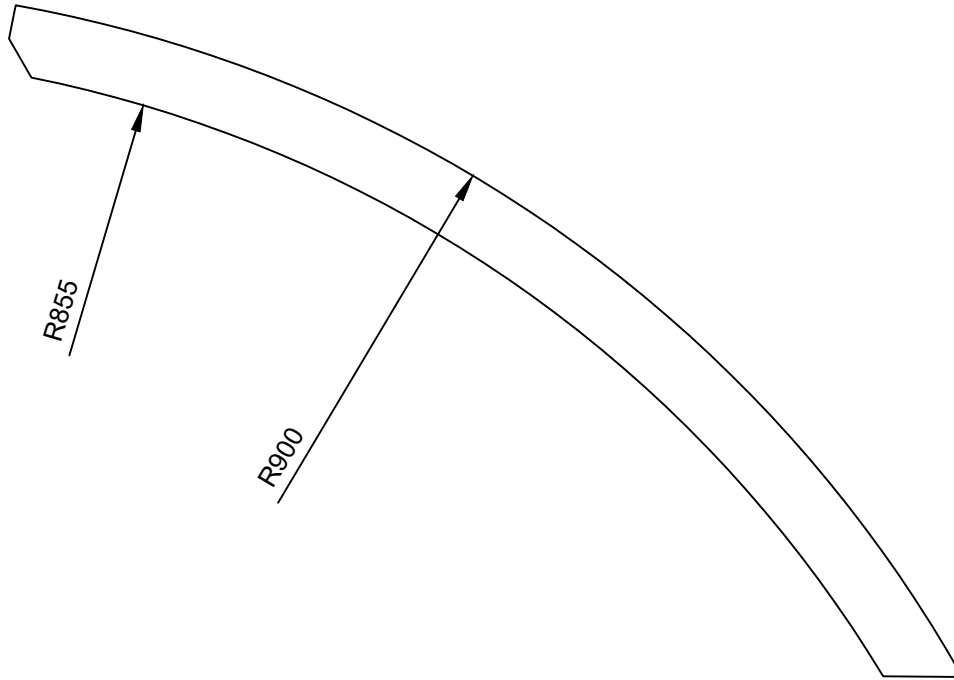

Project: Hafod y Rhedwydd micro-hydro		Title: Sun shield		Projection
Drawing No. HyR_210325b		Designer: Dr. R.W.Moss	Units: mm	Paper size A4
Material:	Required: 1-off	Sheet 6 of 7	Sheet title Item 5: LH end rib	Default scale 1:5
Thickness:			Rev. 0	Revision date 05/07/2020

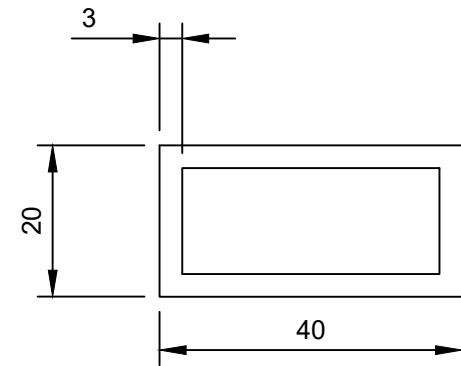
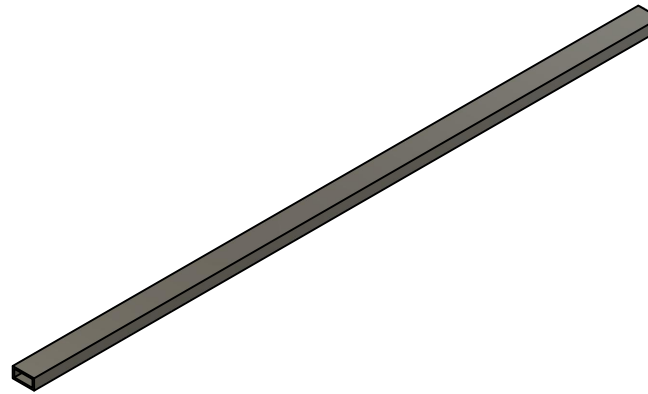
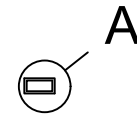
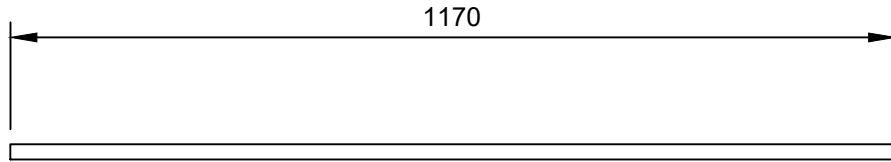

A (1:1)

Project: Hafod y Rhedwydd micro-hydro		Title: Sun shield		Projection
Material: 304L stainless		Drawing No. HyR_210325b		Paper size A4
Thickness:	Required: 1-off	Sheet 7 of 7	Designer: Dr. R.W.Moss	Units: mm
		Sheet title Item 6: Stiffening bar	Rev. 0	Default scale 1:10
			Revision date 05/07/2020	